



PRÉ-ENEM QUÍMICA

AULA 1 ASSUNTO: MASSA MOLAR. PROF. ELDER MAGNO



INSTITUTO FEDERAL
MINAS GERAIS
Campus Congonhas

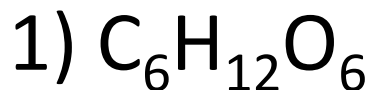

$$\frac{\text{massa do carbono}}{\text{massa molecular}} = \frac{6 \cdot 12}{6 \cdot 12 + 12 \cdot 1 + 6 \cdot 16} = \frac{72 \div 36}{180 \div 36} = \frac{2}{5}$$

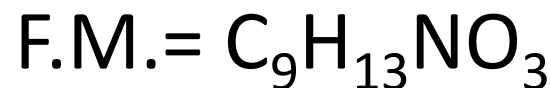
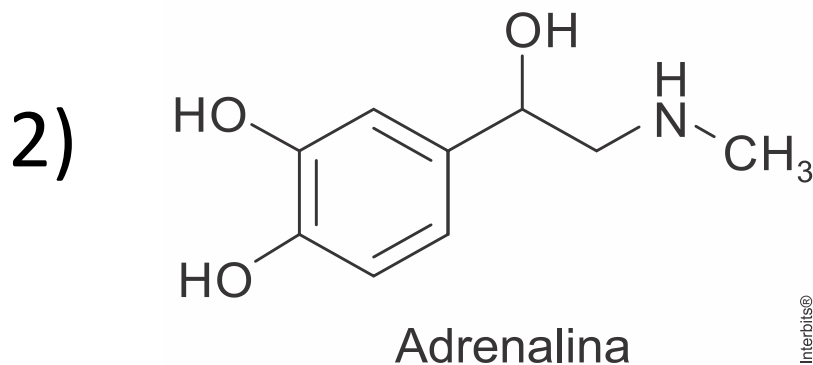

$$M_{C_9H_{13}NO_3} = 9 \times 12 + 13 \times 1 + 1 \times 14 + 3 \times 16 = 183 \text{ g} \cdot \text{mol}^{-1}.$$



PRÉ-ENEM QUÍMICA

AULA 1 ASSUNTO: MASSA MOLAR. PROF. ELDER MAGNO



INSTITUTO FEDERAL
MINAS GERAIS
Campus Congonhas

3) 1 mol de Au = 197g = $6,02 \times 10^{23}$ átomos de Au

$$\text{Au} = 3,0 \text{ g} \quad 75\% = 2,25 \text{ g}$$

$$1 \text{ mol de Au} \text{ ————— } 197 \text{ g}$$

$$x \text{ mol} \text{ ————— } 2,25 \text{ g}$$

$$x = 0,01 \text{ mol}$$

4) 1 mol de Na^+ = 23g = $6,02 \times 10^{23}$ íons Na^+

• 5g de sal = 17 g de Na^+

$$6,0 \times 10^{23} \text{ íons } \text{Na}^+ \text{ ————— } 23 \text{ g}$$
$$x \text{ ————— } 1,7 \text{ g}$$

$$x = 0,443478 \times 10^{23} \text{ íons } \text{Na}^+$$

$$x \approx 4,4 \times 10^{22} \text{ íons } \text{Na}^+$$



PRÉ-ENEM QUÍMICA

AULA 1 ASSUNTO: MASSA MOLAR. PROF. ELDER MAGNO



INSTITUTO FEDERAL
MINAS GERAIS
Campus Congonhas

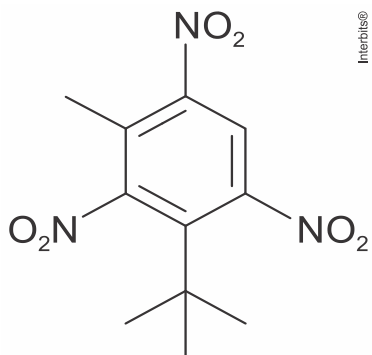
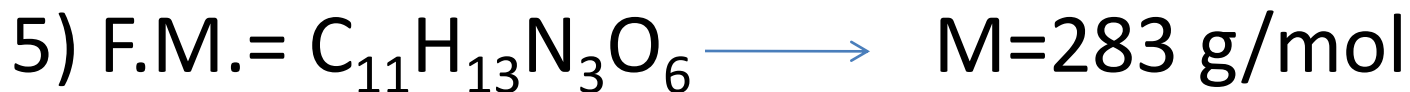

$$283\text{g} \text{ ————— } 6,02 \cdot 10^{23} \text{ moléculas}$$

$$x \text{ ————— } 1 \text{ molécula}$$

$$x = 4,7 \cdot 10^{-22} \text{ g}$$

6)

Bronze : 78 % de cobre (Cu) e 22 % de estanho (Sn).

Cu_{78%} Sn_{22%}

78	22
63,5	118,7

1,228	0,185	⇒	$\frac{1,228}{1,228}$	$\frac{0,185}{1,228}$
			1,0	0,15



7) S-10: 1 Kg de diesel tem 10 mg de enxofre

• $D_{S-10} = 0,8 \text{ Kg/L} \times 1000 \text{ L} = 800 \text{ kg}$ de diesel

1 Kg de diesel-----10 mg de enxofre

800Kg-----X

X= 8000mg=8g de enxofre.

• 1mol de $S_8 = 8 \times 32 \text{ g} = 256 \text{ g}$

• $N = m/M = 8 \text{ g} / 256 \text{ g/mol} = 0,03125$ mol de S_8

• $S_8 + 8 O_2 \rightarrow 8 SO_2$

• N^0 de mols do $SO_2 = 8 \times N^0$ de mols do $S_8 = 8 \times 0,03125 = 0,25$ mol



- 8) [1] Verdadeira. A mudança de cor de roxa para vermelha no segundo experimento é evidência de que ocorreu uma transformação química no extrato, ou seja, houve deslocamento de equilíbrio em relação ao sistema do indicador.
- [2] Falsa. De acordo com o texto, foi observado aspecto opaco (turvo) no extrato líquido, logo em seguida à sua separação das folhas de repolho, e esse aspecto se manteve durante todos os experimentos, ou seja, o sistema não se manteve homogêneo.
- [3] Verdadeira. De acordo com o texto, sobre volume de meio copo do extrato líquido, adicionaram-se de solução salina de cloreto de sódio Então:

- $$\begin{array}{l} 1.000 \text{ mL} \text{ ————— } 1 \text{ mol (NaCl)} \\ 20 \text{ mL} \text{ ————— } n_{\text{NaCl}} \end{array}$$

$$n_{\text{NaCl}} = 0,02 \text{ mol}$$

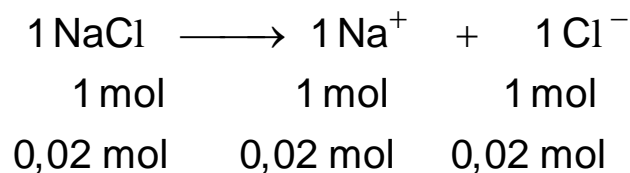

$$0,02 \text{ mol de íons Na}^+ = 0,02 \times 6 \times 10^{23} = 1,2 \times 10^{22} \text{ íons Na}^+$$

$$0,02 \text{ mol de íons Cl}^- = 0,02 \times 6 \times 10^{23} = 1,2 \times 10^{22} \text{ íons Cl}^-$$



- 9) Massa de $P_2O_5 = 30\%$ de 100g do fertilizante = 30 g
- $M_{P_2O_5} = (2 \times 31) + (5 \times 16) = 142$ g
- 142 g de P_2O_5 ----- 2 mol de P

$$30 \text{ g de } P_2O_5 \text{ ----- } X$$

$$X = 0,4225 \text{ mol de P}$$

10) 2 drágeas = 30×10^{-3} mol \longrightarrow 1 drágea = 15×10^{-3} mol

- $M_{Li_2CO_3} = 73,88$ g/mol
- 1 mol de Li_2CO_3 ----- 73,88g

$$15 \times 10^{-3} \text{ mol ----- } X$$

$$X = 1108,2 \times 10^{-3} \text{g}$$

$$\longrightarrow 1,108 \text{g de } Li_2CO_3$$



11)



Figura 1



Figura 2

$d = m/v$, logo ,para uma mesma massa, o líquido mais denso terá menor volume. Podemos observar, pelas bolinhas, que o ácido acético é mais denso que o tolueno, logo, ocupará menor volume, ou seja: Frasco A=tolueno e **Frasco B= ácido acético.**

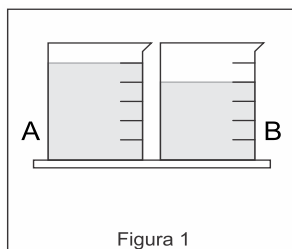
$$d_{\text{acético}} > d_{\text{tolueno}} \Rightarrow V_{\text{acético}} < V_{\text{tolueno}}$$

Conclusão: como V_B é menor do que V_A , conclui-se que o ácido acético está no frasco B.

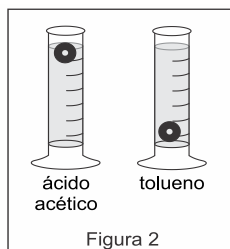
$$d_{\text{acético}} = \frac{m}{V_{\text{acético}}} \Rightarrow m = d_{\text{acético}} \times V_{\text{acético}}$$

$$d_{\text{tolueno}} = \frac{m}{V_{\text{tolueno}}} \Rightarrow m = d_{\text{tolueno}} \times V_{\text{tolueno}}$$

$$n = \frac{m}{M}; M_{\text{C}_2\text{H}_4\text{O}_2} = 60 \text{ g/mol}; M_{\text{C}_7\text{H}_8} = 92 \text{ g/mol}$$

$$\left. \begin{array}{l} n_{\text{acético}} = \frac{m}{60} \\ n_{\text{tolueno}} = \frac{m}{92} \end{array} \right\} (m = m) \frac{m}{92} < \frac{m}{60} \Rightarrow n_{\text{tolueno}} < n_{\text{acético}}$$

Conclusão: $N_A < N_B$.



12) $m_{\text{fósforo}} = 2\%$ da $m_{\text{partícula}}$ e E_c da partícula = $0,1 \text{ m/s} = 10^{-1} \text{ m/s}$

1 mol de P ----- 31g ----- 6×10^{23} átomos

X ----- $1,2 \times 10^{15}$ átomos

X = $62 \times 10^{-9} \text{ g}$ de P (esse valor equivale a 2% da massa da partícula)

$62 \times 10^{-9} \text{ g}$ de P ----- 2% da massa da partícula

Y ----- 100% da massa da partícula $\rightarrow Y = 3,1 \times 10^{-6} \text{ g} = 3,1 \times 10^{-9} \text{ Kg}$

(essa transformação é necessária, devido $J = \text{Kg} \cdot \text{m}^2 / \text{s}^2$)

$$E_c = \frac{1}{2} \times 3,1 \times 10^{-9} \text{ Kg} \cdot (10^{-1} \text{ m/s})^2$$

$$E_c = 1,55 \times 10^{-11} \text{ Kg} \cdot \text{m}^2 / \text{s}^2 \rightarrow E_c = 1,55 \times 10^{-11} \text{ J}.$$



13) $h=15 \text{ cm}$;

$$V_{\text{cilindro}} = \pi \times r^2 \times h$$

$S=2\text{mm}=2 \times 10^{-1} \text{ cm} \rightarrow$ raio do cilindro= $1 \times 10^{-1} \text{ cm}$

$$V_{\text{cilindro}} = \pi \cdot r^2 \cdot h$$

$$V_{\text{cilindro}} = 3,14 \times (10^{-1} \text{ cm})^2 \cdot 15 \text{ cm}$$

$$V_{\text{cilindro}} = \mathbf{0,471 \text{ cm}^3}$$

$$d_{\text{grafite}} = 2,2 \text{ g/cm}^3 \quad \rightarrow \quad \begin{array}{l} 1 \text{ cm}^3 \text{-----} 2,2 \text{ g} \\ 0,471 \text{ cm}^3 \text{-----} X \end{array}$$

X = 1,0362g de grafite

$$\begin{array}{l} 1 \text{ mol de C} \text{-----} 12\text{g} \text{-----} 6 \times 10^{23} \text{ átomos} \\ 0,471\text{g} \text{-----} y \end{array}$$

Y = 5 x 10²² átomos



14) Definimos Progressão Aritmética (P.A) como sendo uma sequência numérica em que cada termo, a partir do segundo, é igual a soma do termo anterior com uma constante. Na P.A temos a presença de uma constante chamada de razão (r), sendo a mesma obtida por meio da diferença de um termo da sequência pelo seu anterior. Confira alguns exemplos:

A sequência (1, 4, 7, 10, 13, 16) é uma P.A.

A razão da P.A é representada por $r = 4 - 1 = 3$

A sequência (1, 6, 11, 16, 21...) é uma P.A.

A razão da P.A é representada por $r = 6 - 1 = 5$



- Quando partimos do primeiro termo da sequência, a fórmula do termo geral de uma P.A ($a_1, a_2, a_3, \dots, a_n, \dots$) de razão r é representada por:

$$a_n = a_1 + (n-1).r$$

a_n = Termo geral

a_1 = Primeiro termo da sequência.

n = Número de termos da P.A. ou posição do termo numérico na P.A

r = Razão



• Resolvendo: $a_n = a_1 + (n-1).r$

$a_1 = 800.000$ carros; $r = 50.000$; $n = 2020 - 2008 = 12$

$a_n = 800.000 + (12-1) \times 50.000$

$a_n = 1.350.000$ carros

Massa de CO_2 emitida por ano:

$m = 1.350.000 \text{ carros} \times 10.000 \text{ Km/carro} \times 160 \text{ g/km}$
 $= 2,16 \times 10^{12} \text{ g de CO}_2 / \text{ano}$

$$n = \frac{m}{M} = \frac{216 \times 10^{10} \text{ g}}{\frac{44 \text{ g}}{\text{mol}}} = 4,9 \times 10^{10} \text{ mol}$$



- 15) ATENÇÃO: A quantidade recomendada é o dobro de 500 mg por dia, ou seja, 1000 mg de cálcio por dia, então:

$$1000 \text{ mg} = 1000 \times 10^{-3} = 1 \text{ g}$$

$$40 \text{ g de cálcio} \text{ ————— } 6 \times 10^{23} \text{ átomos de Ca}$$

$$1 \text{ g de cálcio} \text{ ————— } n_{\text{Ca}}$$

$$n_{\text{Ca}} = 0,15 \times 10^{23} = 1,5 \times 10^{22} \text{ átomos de cálcio}$$



16) De acordo com o enunciado o IDA (índice diário aceitável) desse adoçante é 40 mg/kg de massa corpórea:

1 kg (massa corporal) ————— 40 mg (aspartame)

70 kg (massa corporal) ————— $m_{\text{aspartame}}$

$$m_{\text{aspartame}} = 2800 \text{ mg} = 2,8 \text{ g}$$

294 g ————— 1 mol (aspartame)

2,8 g ————— $n_{\text{aspartame}}$

$$n_{\text{aspartame}} = 9,5 \times 10^{-3} \text{ mol}$$



17)

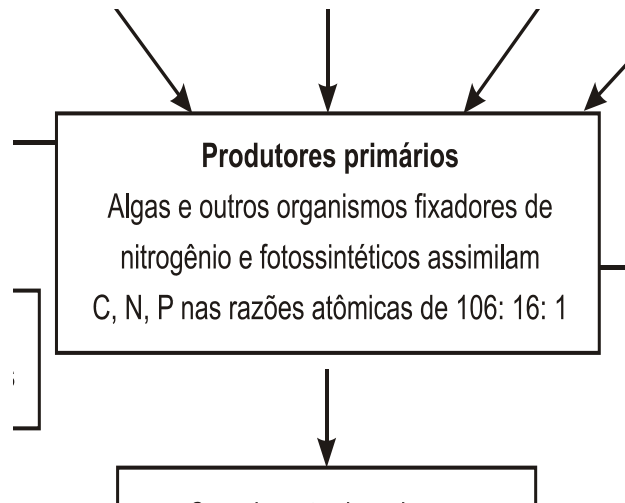

O nutriente limitrofe é aquele encontrado em menor quantidade. De acordo com o enunciado algas e outros organismos fixadores e outros fotossintéticos assimilam C, N, P nas razões atômicas 106:16:1.

A partir dos valores das concentrações dos elementos carbono (21,2 mol/L), nitrogênio (1,2 mol/L) e fósforo (0,2 mol/L), podemos calcular a proporção deles na água do lago.



$$\begin{array}{r} \text{C} \\ 106 \text{ mol/L} \\ 21,2 \text{ mol/L} \\ \hline 0,2 \\ \downarrow \\ 106 \text{ mol/L} \end{array}$$

$$\begin{array}{r} \text{N} \\ 16 \text{ mol/L} \\ 1,2 \text{ mol/L} \\ \hline 0,2 \\ \downarrow \\ 6 \text{ mol/L} \end{array}$$

$$\begin{array}{r} \text{P} \\ 1 \text{ mol/L} \\ 0,2 \text{ mol/L} \\ \hline 0,2 \\ \downarrow \\ 1 \text{ mol/L} \end{array}$$



Limítrofe= Menor quantidade



18) a)

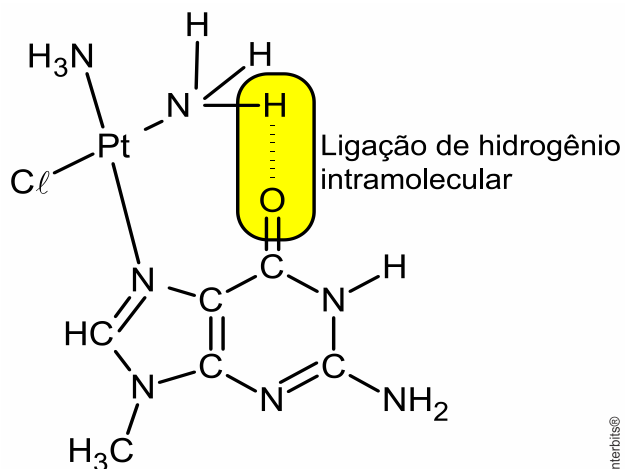

As ligações de hidrogênios intramolecular tornam a guanina mais estável

b) $\text{Pt}(\text{NH}_3)_2\text{Cl}_2 = 195 + (14 + 3) \times 2 + 35,5 \times 2 = 300 \text{ u}$

$$M_{\text{Pt}(\text{NH}_3)_2\text{Cl}_2} = 300 \text{ g/mol}$$

$$n_{\text{cisplatina utilizada}} = 0,050 \text{ mol}$$

$$m_{\text{cisplatina utilizada}} = 0,050 \times 300$$

$$m_{\text{cisplatina utilizada}} = 15 \text{ g}$$

$$50 \times 10^{-3} \text{ g} \text{ ————— } 1 \text{ frasco}$$

$$15 \text{ g} \text{ ————— } n$$

$$n = 3,0 \times 10^2 \text{ frascos}$$

$$n = 300 \text{ frascos}$$



19)a)

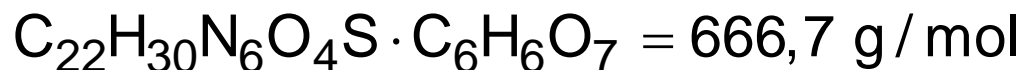

$$1 \text{ mol} \text{ ————— } 666,7 \text{ g}$$

$$5,2 \times 10^{-5} \text{ mol} \text{ ————— } m_{\text{C}_{22}\text{H}_{30}\text{N}_6\text{O}_4\text{S} \cdot \text{C}_6\text{H}_6\text{O}_7}$$

$$m_{\text{C}_{22}\text{H}_{30}\text{N}_6\text{O}_4\text{S} \cdot \text{C}_6\text{H}_6\text{O}_7} = 3.466,84 \times 10^{-5} \text{ g}$$

$$m_{\text{C}_{22}\text{H}_{30}\text{N}_6\text{O}_4\text{S} \cdot \text{C}_6\text{H}_6\text{O}_7} \approx 34,67 \times 10^{-3} \text{ g}$$

$$m_{\text{C}_{22}\text{H}_{30}\text{N}_6\text{O}_4\text{S} \cdot \text{C}_6\text{H}_6\text{O}_7} \approx 34,67 \text{ mg}$$

$$34,67 \text{ mg} < 50 \text{ mg (especificação)}$$

Conclusão: o produto está fora da especificação.



b)

$$N = 14 \text{ g/mol}$$

$$C_{22}H_{30}N_6O_4S \cdot C_6H_6O_7 \text{ (citrato de sildenafil) } = 666,7 \text{ g/mol}$$

$$666,7 \text{ g} \text{ ————— } 100 \%$$

$$6 \times 14 \text{ g} \text{ ————— } p_N$$

$$p_N \approx 12,60 \%$$

$$C_{22}H_{19}N_3O_4 \text{ (tadalafila) } = 389,4 \text{ g/mol}$$

$$389,4 \text{ g} \text{ ————— } 100 \%$$

$$3 \times 14 \text{ g} \text{ ————— } p'_N$$

$$p'_N \approx 10,79 \%$$

Conclusão: seria possível diferenciar entre o citrato de sildenafil e a tadalafila, a partir do teor de nitrogênio presente em cada amostra, já que as porcentagens de nitrogênio são diferentes nas amostras analisadas.



20)

A partir da fórmula estrutural teremos:

Fórmula molecular: $C_{10}H_{15}O_3N_5$ ou $C_{10}H_{15}N_5O_3$

Massa molar = $10 \times 12 + 15 \times 1 + 3 \times 16 + 5 \times 14 = 253 \text{ g.mol}^{-1}$

O paciente toma a cada 12 horas um comprimido, logo em um dia toma 2 comprimidos, que equivalem a $2 \times 125 \text{ mg}$ ($250 \times 10^{-3} \text{ g}$).

$253 \text{ g} \text{-----} 6,02 \times 10^{23} \text{ moléculas}$

$250 \times 10^{-3} \text{ g} \text{-----} y$

$y = 5,95 \times 10^{20} \text{ moléculas.}$

O paciente ingere por dia $5,95 \times 10^{20}$ moléculas do penciclovir.



21)

a) Massa de sódio ingerido na salada com pão:

$$m = 30\text{mg} + 50\text{mg} + 750\text{mg} + 157\text{mg} = 990\text{mg}$$

Cálculo da porcentagem de sódio ingerida (considerando o mínimo de 1100mg de sódio)

$$1100\text{mg} \text{ ______ } 100\%$$

$$990\text{mg} \text{ ______ } x$$

$$x = 90\%$$

O percentual da necessidade diária mínima de sódio será de 90%.



b) Massa de sódio que deve ser acrescentada para satisfazer a necessidade máxima de 3300mg:
 $m' = 3300\text{mg} - 990\text{mg} = 2310\text{mg} = 2,310\text{g de Na}$

Massa molar de NaCl = $(22,990 + 35,453)\text{g/mol} = 58,443\text{g/mol}$

$$\begin{array}{r} 58,443\text{g de NaCl} \quad \underline{\hspace{2cm}} \quad 22,990 \text{ de Na} \\ x \quad \underline{\hspace{4cm}} \quad 2,310\text{g de Na} \end{array}$$

$$\mathbf{x = 5,872\text{g de NaCl}}$$



22)

a) Inicialmente vamos determinar a massa da gotícula:

$$1 \text{ mL} \text{ -----} 0,904 \text{ g}$$

$$3,10 \cdot 10^{-3} \text{ mL} \text{ -----} x$$

$$x = 2,802 \cdot 10^{-3} \text{ g/gota}$$

A seguir, vamos calcular a massa molar do ácido:

$$2,802 \cdot 10^{-3} \text{ g} \text{ -----} 6,0 \cdot 10^{18} \text{ moléculas}$$

$$y \text{ -----} 6,0 \cdot 10^{23} \text{ moléculas}$$

$$y = 280 \text{ g}$$



Logo, a massa molar do ácido é $280 \text{ g} \cdot \text{mol}^{-1}$.

O cálculo da fórmula molecular pode ser feito da seguinte maneira:

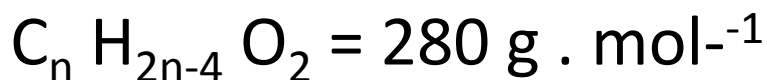

$$12 \cdot n + 1(2n - 4) + 16 \cdot 2 = 280$$

$$12n + 2n - 4 + 32 = 280$$

$$14n = 252 \quad n = 18$$

Assim, temos a fórmula molecular do ácido:

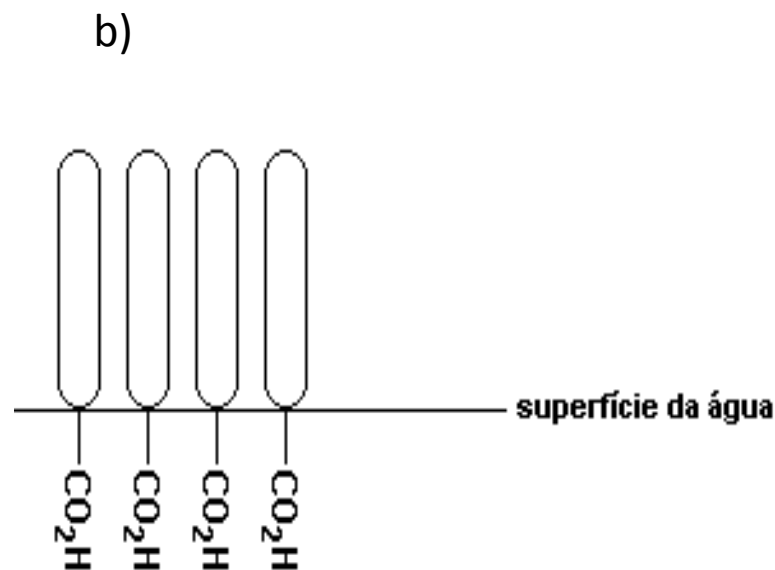
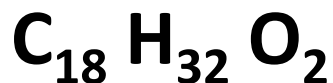



23)

Cálculo da altura da película de ácido que se forma sobre a água

$$V = A \cdot h$$

$$1,6 \cdot 10^{-5} \text{cm}^3 = 200 \text{cm}^2 \cdot h$$

$$h = 8,0 \cdot 10^{-8} \text{cm}$$

Cálculo do volume da molécula (considerando-a cúbica)

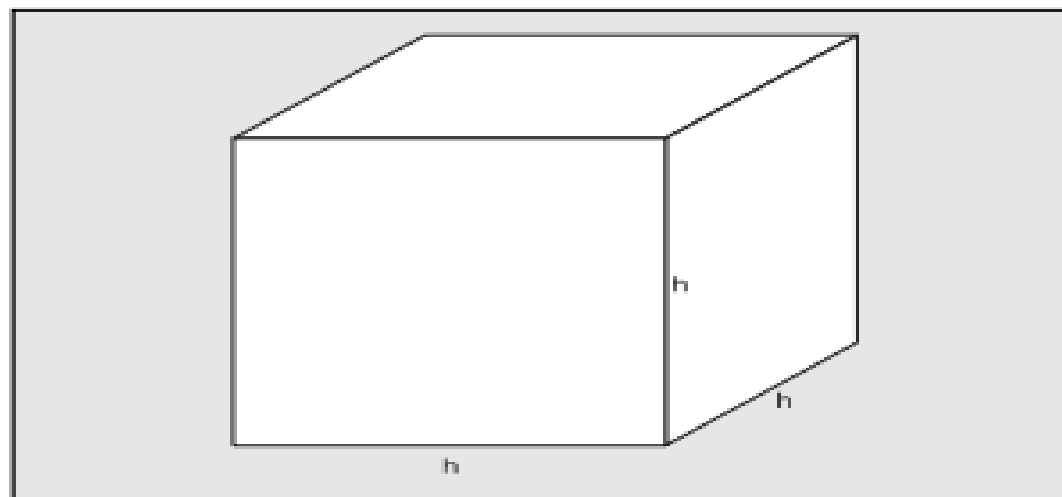
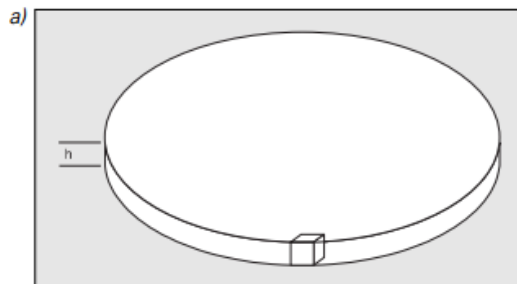

$$V_{\text{molécula}} = h^3$$

$$V_{\text{molécula}} = (8,0 \cdot 10^{-8} \text{cm})^3$$

$$V_{\text{molécula}} = 5,12 \cdot 10^{-22} \text{cm}^3$$



b) **Cálculo do volume ocupado por 282g do ácido orgânico**

$$d = \frac{m}{V}$$

$$0,9\text{g/cm}^3 = \frac{282\text{g}}{V}$$

$$V = 313\text{cm}^3$$

Cálculo do número de moléculas

$$1 \text{ molécula} \text{ ————— } 5,12 \cdot 10^{-22}\text{cm}^3$$

$$x \text{ ————— } 313\text{cm}^3$$

$$x = 6,1 \cdot 10^{23} \text{ moléculas}$$